



Commissioning at  
your finger tips.

**Butterfly valves**



Visit us at  
[belimo.com](http://belimo.com)

**BELIMO**<sup>®</sup>

# Efficiency and reliability in versatile applications.



Kuhn Champignon AG, Full-Reuenthal (Switzerland)

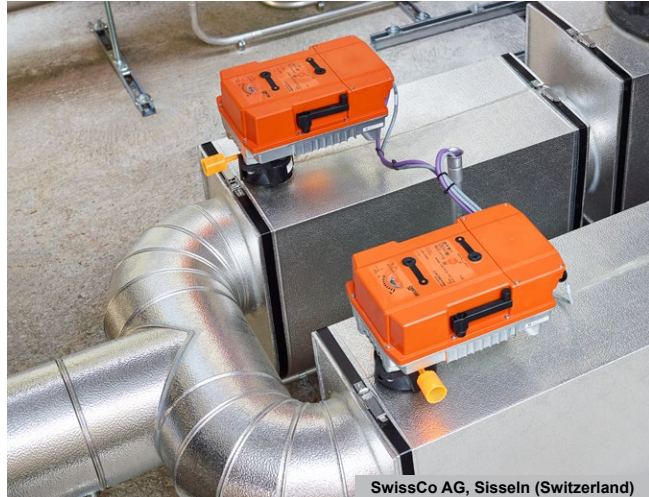

SwissCo AG, Sisseln (Switzerland)



Alois Müller GmbH, Memmingen (Germany)

Thanks to their reliability, flexibility and energy efficiency, many customers have become devotees of Belimo butterfly valves and PR actuators since they were launched in November 2016. The butterfly valve-actuator combinations have already been able to prove themselves in projects such as the new chiller of the SwissCo AG pharmacy group, the heating system of the Kuhn Champignon AG food manufacturing company or as a retrofit solution in the cooling plant of the Müller Produktion GmbH installation company.

Thanks to their communication capability, the actuators were readily integrated in the existing systems, commissioned or configured in just a few minutes, providing information regarding their operating status. In combination with the specially developed butterfly valves, they ensure optimum performance and contribute towards reducing energy consumption.

# The latest technology for butterfly valves.

In the Heating, Ventilation and Air Conditioning Industry (HVAC), butterfly valves are fundamental components in virtually every hydronic system.

Most butterfly valves available on the market are less than ideal for this field of application – they leak, their running times are not optimised for HVAC applications, they are too big and heavy for easy installation and they cannot be commissioned quickly in the field. However, the tested and trusted Belimo butterfly valves are the exception here.

The latest technology for butterfly valves from Belimo is especially designed for the Heating, Ventilation and Air Conditioning industry and fully meets all of its requirements. Belimo is setting new standards here.



## Innovative

The actuator and the valve design allow a reduction in investment costs as well as energy savings of up to 80%. Intelligent self-adjusting end stops ensure that they are easy to mount and commission.



## User-friendly

Optimised mechanical layout and easy to mount made possible thanks to the reduced height and weight of the actuator. Flexible visual position indication and the NFC capability enable fast installation, good visibility of the valve position, as well as easy commissioning and troubleshooting – even when the actuator is not connected to the power supply.



## Reliable

Thanks to the 5-year warranty, Belimo is the best choice for your application. Backed with more than 40 years of design experience, the newly designed butterfly valves and PR actuators with its long-life brushless DC motor are perfectly coordinated with one another.

"Using the new PRK actuator with emergency control function from Belimo was no risk for us. Products from Belimo convince with reliability."

**Darko Zanic, Project Manager**  
**MSR-Technik, e-con AG**

"The communicative PR actuator allows us to see at any time whether the system is working properly. With NFC (Near Field Communication) I was able to commission the PR actuators in just a few minutes from my own smartphone. It is really easy to do and saves a lot of time."

**Andreas Wechner, Project Manager**  
**Trane (Schweiz) GmbH**



# Flexible for every application.

Belimo butterfly valves can be used universally for chiller isolation, cooling tower isolation, change-over systems, large air handler coil control and bypass applications. This flexibility is guaranteed by the energy-efficient and multifunctional PR actuators. PR actuators are equipped with Near Field Communication (NFC) and enable rapid commissioning and parametrisation via your smartphone.

## Belimo butterfly valves



	2-way, open/close	2-way, control	2-way, control, fail safe
Control	open/close, 3-point	2...10 V, 0.5...10 V, 4...20 mA, 3-point	2...10 V, 0.5...10 V, 4...20 mA, 3-point
Flange	wafer-type and lug-type flange		
Emergency control function	–	–	Yes
Sensor inputs	–	two sensors can be connected for each PR actuator	two sensors can be connected for each PR actuator
Communication	–	BACnet MS/TP, Modbus RTU, MP-Bus or conventional	BACnet MS/TP, Modbus RTU, MP-Bus or conventional

## 100 % tight for cooling and heating generation

The Belimo wafer-type or lug-type open-close butterfly valves are tested and trusted, tight-closing devices – with up to 14 bar closing pressure (leakage rate A, tight). In addition to motorisation with Belimo rotary actuators, the open/close butterfly valve is also available with lever or worm gear.

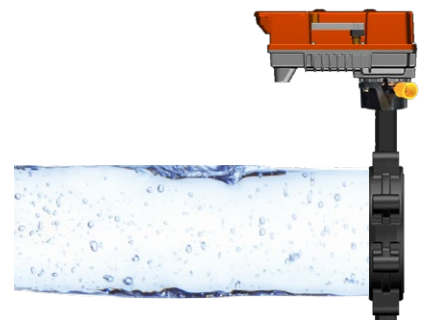

Tight-closing butterfly valve

## Universal power supply

24-240 VAC / 24-125 VDC requires only one actuator, facilitates planning and increases flexibility for all applications. Connection box is designed for easy wiring access and little space is needed to be reserved for maintenance.



## Fit for reliable control tasks

The Belimo butterfly valves have a virtually equal-percentage characteristic curve for opening angles between 0 and 60%. Depending on the desired  $K_v$  value, the opening angle can be set via Near Field Communication (NFC) with the Belimo Assistant App on a smartphone. Which means that Belimo butterfly valves are ideally suited for use as control device.

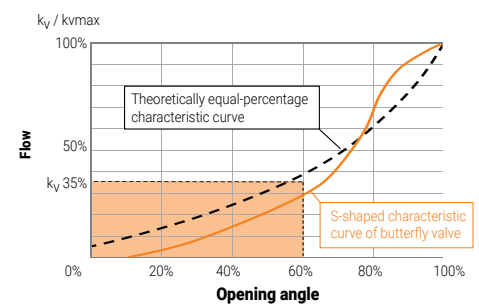

## Simple commission thanks to NFC

The butterfly valve actuators can be configured using the Belimo Assistant App, which means that the control, running time and maximum opening angle of the butterfly valve can be set for each application.

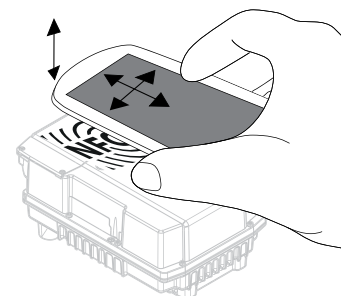

# Innovative, user friendly and reliable.



## Universal power supply

24 – 240 V facilitates planning and increases flexibility for all applications.



## Near Field Communication (NFC)

enables fast commissioning, configuration and maintenance – even when the actuator has no voltage supply.



## Adjustable motor running time

from 30 to 120 seconds to meet the requirements of your application.

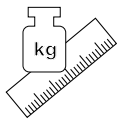

## Thanks to reduced height and weight

the PR actuator ensures simple planning and mounting.



## IP66/67 housing

allows for outdoor usage and protects the actuator against UV radiation, rain, snow, dirt, dust, and humidity.

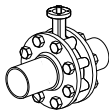

## Valve housing

available with wafer or lug types for flanges according to ISO 7005-1/-2, EN 1092-1/-2 DIN 2641/2642.

**2-way, open/close or control butterfly valve with emergency control function**  
ensures operating safety during a power failure.



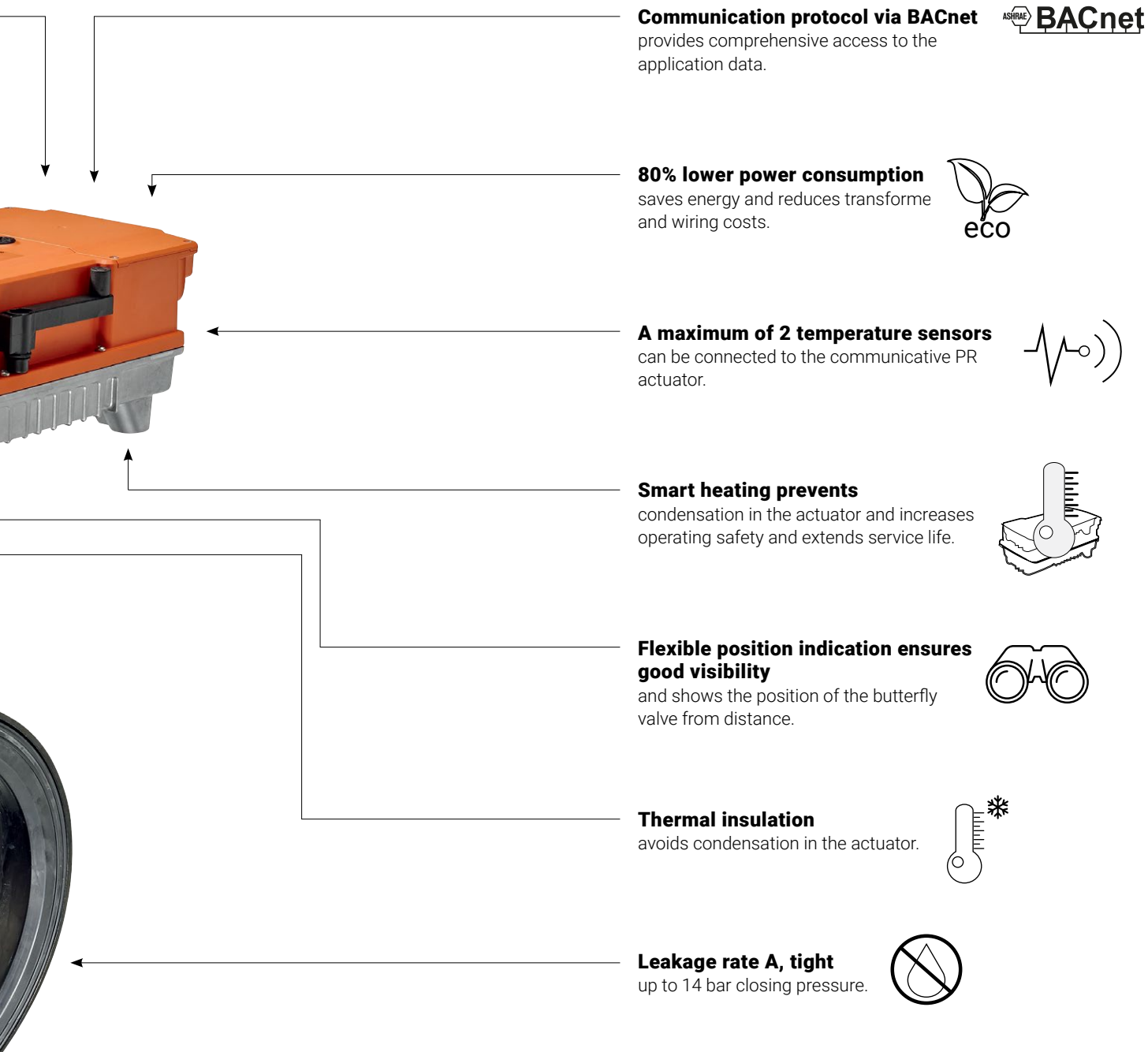

# Specially designed for the HVAC industry.

The butterfly valves and PR actuators from Belimo are the most intelligent, energy-efficient, and most reliable solution for high flows on the HVAC market. Having focused on ease of installation, application flexibility and longevity, this series sets new performance standards in HVAC industry. The Belimo butterfly valve actuators are the solution for heating, chiller and cooling tower applications, for change-over systems, as well as control applications in large ventilation systems and bypass applications.

## Simple installation

Thanks to the low overall height and reduced weight of the actuator, it is easy to install the Belimo PR actuator. It can be mounted on the Belimo butterfly valve with just two screws.

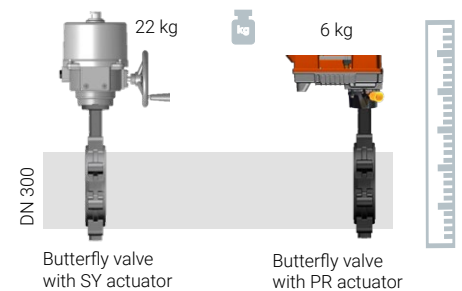

## Up to 80 % energy savings

Thanks to the new valve design, the contact surface between the valve seal and valve disk is reduced. This ensures a low torque over the entire service life. With up to 80% less power consumption, the valve-actuator combination saves energy and reduces transformer and wiring costs.

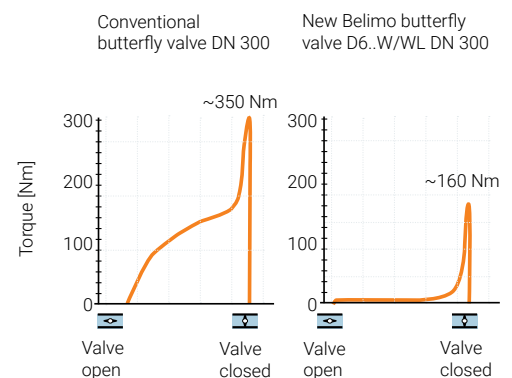

## Good visibility

Flexible visual position indication shows the position of the butterfly valve from distance. At the same time, the linkage acts as thermal insulation, preventing condensation in the actuator.





## Smart heating prevents condensation

The integrated temperature and humidity sensor ensure that the integrated intelligent heating only switches on when required by the environmental condition. This means that the formation of condensation water in the actuator can be prevented.

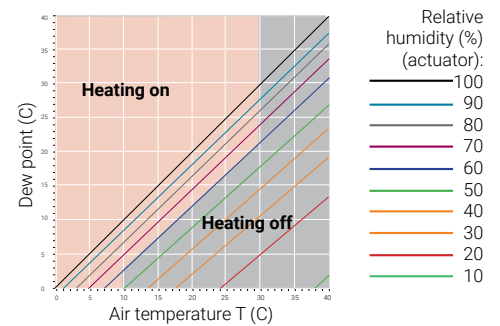

## Communicative actuator for flexible configurations

The communicative PR actuator enables expanded data access with diagnostics options and offers flexible configuration possibilities: open/close, 3-point, DC 0.5...10 V, DC 2...10 V, 4...20 mA, MP-Bus®, Modbus RTU and BACnet MS/TP. With the Belimo Assistant App, the types of control and bus parameters are easy to set using Near Field Communication (NFC).

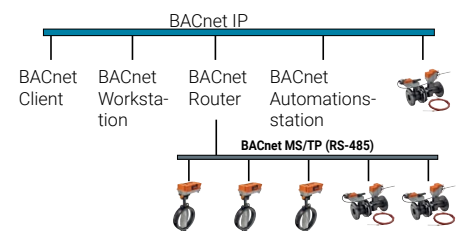

## Seamlessly integrated temperature measurement

The Belimo temperature sensors can be easily connected to the communicative PR actuators, providing a system solution that works perfectly. Two sensor inputs for passive temperature sensors provide accurate measurement data via the BACnet MS/TP or Modbus RTU protocol.

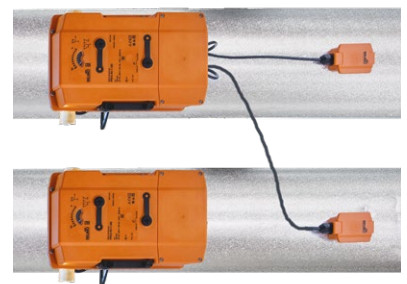

## High level of safety during power failure

The emergency control function of the reliable PRK actuator enables high operation reliability for your plant. The butterfly valve moves to its specified position in the event of a power failure. This can be set between 0 and 100% using the Belimo Assistant App.



# Belimo Assistant App: Configuration and diagnostics.

## Simple commissioning thanks to NFC

The PR actuator can be easily configured via smartphone, even if the actuator is not connected to the power supply. The health status of the PR actuator can be checked at any time using the diagnostics parameters. The PR actuator with Near Field Communication (NFC) allows easy commissioning, configuration and maintenance directly from a smartphone. Fast commissioning saves time and has never been easier.



Simple commissioning directly via smartphone or the Bluetooth NFC converter ZIP-BT-NFC using Near Field Communication (NFC).

## Reliable operation guaranteed

Key performance indicators reveal the state of the health of the actuator to ensure reliable operation. At the same time, numerous diagnostics parameters provide the user with an impression of how the product interacts with the system during ongoing operation. Rapid failure analysis is made possible, should a service call become necessary.



Display of the diagnostics parameters in the Belimo Assistant App.

## Belimo Assistant App

Display, configuration and diagnostics for Belimo actuators and HVAC performance devices with an NFC interface, even when de-energised. Install the app via the App Store or Google Play. The QR codes take you there directly.



# Retrofit solution for third-party butterfly valves.

Belimo produces universal actuators for motorising existing installations. With the help of simple adapters, these actuators can be mounted on installed butterfly valves from a variety of manufacturers.

## PR actuators from Belimo

Whether as standard PR actuator for open/close or 3-point applications, BACnet actuator for modulating and bus applications or as actuator with emergency control function – the PR actuator can be used universally as a retrofit solution.

## Retrofit linkage from Belimo

Adapter to connect third-party butterfly valves and PR actuator from Belimo: ZPR05...ZPR14.



Retrofit installation with PRK actuator with emergency control function and ZPR linkage.

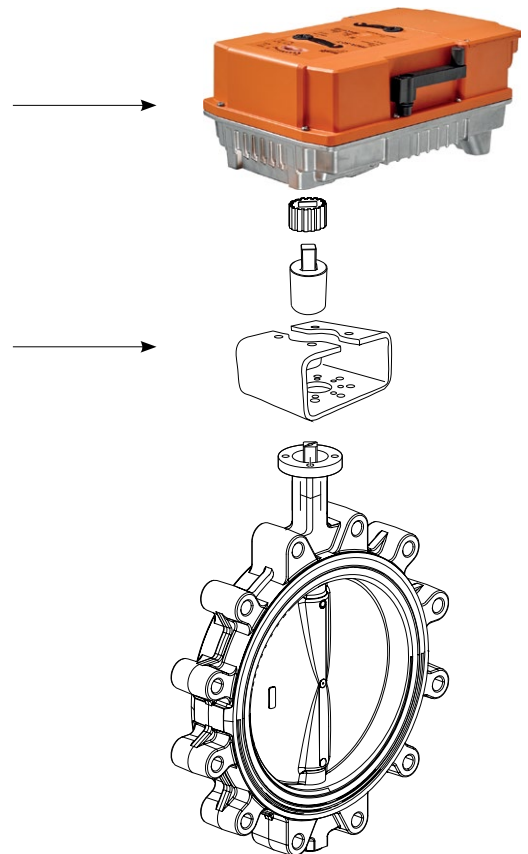

## Retrofit tool

Convenient replacement and modernisation of actuators in existing installations. Install the app via the App Store or Google Play. The QR code takes you there directly.



# All inclusive.

Belimo as a global market leader develops innovative solutions for the controlling of heating, ventilation and air-conditioning systems. Actuators, valves and sensors represent our core business.

Always focusing on customer added value, we deliver more than only products. We offer you the complete product range for the regulation and control of HVAC systems from a single source. At the same time, we rely on tested Swiss quality with a five-year warranty. Our worldwide representatives in over 80 countries guarantee short delivery times and comprehensive support through the entire product life. Belimo does indeed include everything.

The "small" Belimo devices have a big impact on comfort, energy efficiency, safety, installation and maintenance.  
In short: Small devices, big impact.



5-year warranty



On site around the globe



Complete product range



Tested quality



Short delivery times



Comprehensive support