



Symaro™

## Duct sensors

QFM21..

for relative humidity and temperature

- 
- Operating voltage AC 24 V / DC 13.5...35 V
  - Signal output DC 0...10 V / 4...20 mA for relative humidity
  - Signal output DC 0...10 V / 4...20 mA / LG-Ni 1000 for temperature
  - Measuring accuracy  $\pm 3$  % r. h. within the comfort range
  - Range of use  $-15...+60$  °C / 0...95 % r. h. (non-condensing)

### Use

---

The QFM21.. duct sensors are for use in air ducts of ventilation and air conditioning plant for acquiring:

- The relative humidity and
- The temperature.

The sensors are used as:

- Control sensors in the supply or extract air
- Reference sensors, e.g. for shifting the dew point
- Limit sensors, e.g. in connection with steam humidifiers
- Limit sensors, e.g. for measured value indication or for connection to a building automation and control system
- Sensors for enthalpy and absolute humidity, together with SEZ220 (see Data Sheet N5146)

## Type summary

Type reference	Temperature measuring range	Temperature signal output	Humidity measuring range	Humidity signal output	Operating voltage
QFM2100	None	None	0...100 %	active, DC 0...10 V	AC 24 V or DC 13.5...35 V
QFM2101	None	None	0...100 %	active, 4...20 mA	DC 13.5...35 V
QFM2120	-35...+50 °C	passive, LG-Ni 1000	0...100 %	active, DC 0...10 V	AC 24 V or DC 13.5...35 V
QFM2160	0...50 °C / -35...+35 °C or -40...+70 °C	active, DC 0...10 V	0...100 %	active, DC 0...10 V	AC 24 V or DC 13.5...35 V
QFM2171	0...50 °C / -35...+35 °C or -40...+70 °C	active, 4...20 mA	0...100 %	active, 4...20 mA	DC 13.5...35 V

## Ordering and delivery

When ordering, please give name and type reference, e.g.:

Duct sensor **QFM2120**

The sensor is supplied with mounting flange and cable entry gland M16

## Equipment combinations

All systems and devices capable of acquiring and handling the sensor's DC 0...10 V, 4...20 mA or LG-Ni 1000 output signal.

When using the sensors for minimum or maximum selection, for averaging, or to calculate enthalpy, enthalpy difference, absolute humidity, and dewpoint, we recommend to use the SEZ220 signal converter (see Data Sheet N5146).

## Function

### Relative humidity

The sensor acquires the relative humidity in the air duct via its capacitive humidity sensing element whose electrical capacitance changes as a function of the relative humidity.

The electronic measuring circuit converts the sensor's signal to a continuous DC 0...10 V or 4...20 mA signal, which corresponds to 0...100 % r. h.

### Temperature

The sensor acquires the temperature in the air duct via its sensing element whose electrical resistance changes as a function of the temperature.

Depending on the type of sensor this change in resistance is converted either to an active DC 0...10 V or 4...20 mA output signal corresponding to a temperature range of 0...50 °C, -35...+35 °C, or -40...+70 °C. The measuring range can be selected. The temperature is provided as a simulated passive LG-Ni 1000-output signal ( $\cong$  -35...50 °C) as an alternative to the active output signal.

### Simulated passive output signal

The measuring current of systems/devices for acquiring the electrical resistance of the passive sensor differs greatly and impacts self-heating of the temperature sensing element at the end of the measuring tip. To compensate the impact, the passive output signal is simulated with an electronic circuit.

### Sensing elements, simulated LG-Ni 1000

#### Characteristic:

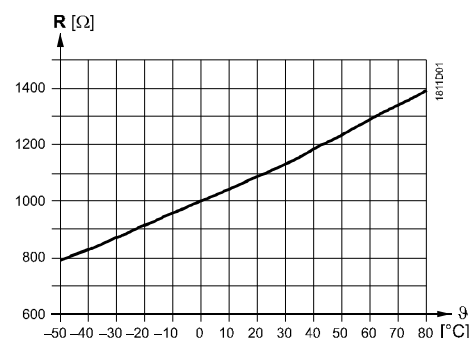

**Legend**

- R Resistance value in Ohm
- θ Temperature in degrees Celsius

**Burden diagram**

Output signal, terminal I1 / I2

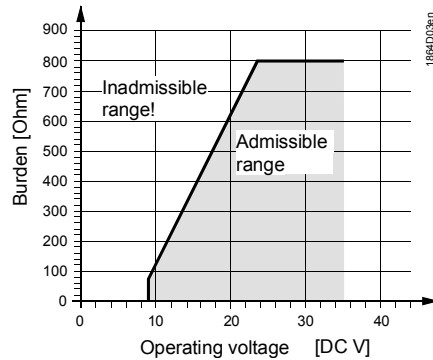

**Mechanical design**

The duct sensor consists of a housing, a printed circuit board, connection terminals, a mounting flange and an immersion rod having a measuring tip. The 2-sectional housing comprises a base and a removable cover (snap-on design). The measuring circuit and the setting element are located on the printed circuit board inside the cover, the connection terminals on the base. The sensing elements are located at the end of the measuring tip and protected by a filter cap. Cable entry is made via the screwed cable gland M16 supplied with the sensor. Immersion rod and housing are made of plastic and are rigidly connected.

The sensor is fitted with the mounting flange supplied with the sensor. The flange is to be placed over the immersion rod and then secured in accordance with the required immersion length.

**Setting element**

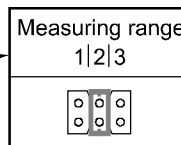
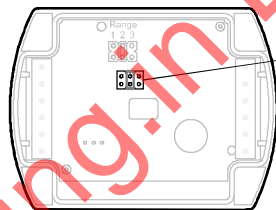

	Test function active				
	U1	U2	BS-MS	I1	I2
	10 V	5 V	≅ 20 °C	20 mA	12 mA
	5 V	10 V	≅ 75 °C	12 mA	20 mA
	0 V	5 V	≅ 20 °C	4 mA	12 mA
	5 V	0 V	≅ -35 °C	12 mA	4 mA

The setting element is located inside the cover. It comprises 6 pins and a jumper. It is used to select the required measuring range and to activate the test function.

The different jumper settings have the following meaning:

- *For the passive temperature measuring range:*  
Jumper in the middle position (R2) = -35...+50 °C (factory setting)
- *For the active temperature measuring range:*  
Jumper in the left position (R1) = -35...+35 °C,  
Jumper in the middle position (R2) = 0...50 °C (factory setting)  
Jumper in the right position (R3) = -40...+70 °C
- *For activating the test function:*  
Jumper in the horizontal position: The values according to the table "Test function active" will be made available at the signal output.

Malfunction

- Should the temperature sensor become faulty a voltage of 0 V (4 mA) will be applied at signal output U2 (I2) or signal output BS-MS becomes high impedance (>1 MΩ) after 60 seconds, and the humidity signal at signal output U1 (I1) will reach 10 V (20 mA).
- Should the humidity sensor become faulty a voltage of 10 V (20 mA) will be applied at signal output U1 (I1) after 60 seconds, and the temperature signal will remain active.

Accessories

Name	Type reference
Filter cap (for replacement)	AQF3101

Engineering notes

A transformer for safety extra low-voltage (SELV) with separate windings for 100 % duty is required to power the sensor. When sizing and protecting the transformer, local safety regulations must be complied with.

When sizing the transformer, the power consumption of the duct sensor must be taken into consideration.

For correct wiring, refer to the Data Sheets of the devices with which the sensor is used.

The permissible cable lengths must be considered.

Cable routing and cable selection

It must be considered for routing of cables that the longer the cables run side by side and the smaller the distance between them, the greater electrical interference. Shielded cables must be used in environments with EMC problems.

Twisted pair cables are required for the secondary supply lines and the signal lines.

Note to QFM2171

Terminals G1(+) and I1(-) of the humidity output must always be connected to power, even if only terminals G2(+) and I2(-) of the temperature output are used!

## Mounting notes

---

**Location** Mount the sensor in the center of the duct wall. If used together with steam humidifiers, the minimum distance after the humidifier must be 3 m to max 10 m.  
Fit the sensor in the extract air duct if the application involves dew point shifting.  
Fit only the flange to the duct wall. The sensor is then inserted through the flange and engaged.

**Caution!**

- To ensure degree of protection IP54, fit the sensor with the cable entry pointing downward.
- The sensing elements inside the measuring tip are sensitive to impact. Avoid any impact on mounting.

**Mounting instructions** The mounting instructions are printed on the inside of the package of the device.

**Chemical vapors** It is of great importance to understand that a humidity sensor is a sensitive measure device and needs to be handled with care. Chemical vapors at high concentration in combination with long exposure times may offset the sensor reading.

## Commissioning notes

---



Check wiring before switching on power. The temperature measuring range must be selected on the sensor, if required.

Wiring and the output signals can be checked by making use of the test function (refer to "Mechanical design").

To ensure the accuracy of the temperature measurement of the QFM2120 the test function has to be activated and on the controller side the values have to be adjusted. We recommend not to use voltmeters or ohmmeters directly at the sensing element. In the case of the simulated passive output signals, measurements with commercially available meters cannot be made (measuring current too small).

## Disposal

---



The device is considered electrical and electronic equipment for disposal in terms of the applicable European Directive and may not be disposed of as domestic garbage.

- Dispose of the device through channels provided for this purpose.
- Comply with all local and currently applicable laws and regulations.

## Technical data

Power supply	Operating voltage	AC 24 V $\pm$ 20 % or DC13.5...35 V (SELV) or AC/DC 24 V class 2 (US)
	Frequency	50/60 Hz at AC 24 V
	External supply line protection	Fuse slow max. 10 A or Circuit breaker max. 13 A Characteristic B, C, D according to EN 60898 or Power source with current limitation of max. 10 A
	Power consumption	$\leq$ 1 VA
	Cable lengths for measuring signal	Perm. cable lengths
Functional data of humidity sensor	Range of use	0...95 % r. h. (non-condensing)
	Measuring range	0...100 % r. h.
	Measuring accuracy at 23 °C and AC/DC 24 V in	
	0...95 % r. h.	$\pm$ 5 % r. h.
	30...70 % r. h.	$\pm$ 3 %, r. h. typically
	Time constant at 0...50 °C and 10...80 % r.h.	< 20 s
	Perm. air velocity	20 m/s
	Output signal, linear (terminal U1)	DC 0...10 V $\hat{=}$ 0...100 % r. h., max. 1 mA
	Output signal, linear (terminal I1)	4...20 mA $\hat{=}$ 0...100 % r. h.
	Burden	See "Function"
Functional data of temperature sensor with QFM2160, QFM2171	Measuring range	0...50 °C (R2 = factory setting), -35...+35 °C (R1) or -40...+70 °C (R3)
	Measuring accuracy at AC/DC 24 V in	
	23°C	$\pm$ 0.3 K
	15...35 °C	$\pm$ 0.7 K
	-35...+50 °C	$\pm$ 1 K
	Time constant	< 3.5 min. in with 2 m/s moved air
	Output signal, linear (terminal U2)	DC 0...10 V $\hat{=}$ 0...50 °C / -35...+35 °C /-40...+70 °C max. 1 mA
	Output signal, linear (terminal I2)	4...20 mA $\hat{=}$ 0...50 °C / -35...+35 °C /-40...+70 °C
	Burden	See "Function"
	Functional data of temperature sensor with QFM2120	Measuring range
Sensing element simulated, corresponding to QFM2120		LG-Ni 1000
Measuring accuracy at AC/DC 24 V		
in the range of		
23°C		$\pm$ 0.3 K
15...35 °C		$\pm$ 0.7 K
-35...+50 °C	$\pm$ 1 K	
Time constant	< 3.5 min. in with 2 m/s moved air	
Perm. measuring current with QFM2120	1.18...4.21 mA	
Degree of protection	Protection degree of housing	IP54 according to EN 60529 in built-in state
	Protection class	III according to EN 60730-1
Electrical connections	Connection terminals for	1 $\times$ 2.5 mm <sup>2</sup> or 2 $\times$ 1.5 mm <sup>2</sup>
	Cable entry gland (enclosed)	M 16 x 1.5

Environmental conditions	Operation	IEC 60721-3-3
	Climatic conditions	Class 3K5
	Temperature (housing with electronics)	-15...+60 °C
	Humidity	0...95 % r. h. (non-condensing)
	Mechanical conditions	Class 3M2
	Transport	IEC 60721-3-2
	Climatic conditions	Class 2K3
	Temperature	-25...+70 °C
	Humidity	<95 % r. h.
	Mechanical conditions	Class 2M2
Materials and colors	Base	Polycarbonate, RAL 7001 (silver-grey)
	Cover	Polycarbonate, RAL 7035 (light-grey)
	Immersion rod	Polycarbonate, RAL 7001 (silver-grey)
	Filter cap	Polycarbonate, RAL 7001 (silver-grey)
	Mounting flange	PA66 – GF35 (black)
	Cable entry gland	PA, RAL 7035 (light-grey)
	Sensor (complete assembly)	Silicone-free
	Packaging	Corrugated cardboard
Directives and Standards	Product standard	EN 60730-1 Automatic electrical controls for household and similar use
	Electromagnetic compatibility (Applications)	For use in residential, commerce, light-industrial and industrial environments
	EU Conformity (CE)	CE1T1864xx <sup>2)</sup>
	RCM Conformity	CE1T1864en_C1 <sup>2)</sup>
	UL	UL 873 <sup>1)</sup> , <a href="http://ul.com/database">http://ul.com/database</a>
Environmental compatibility	The product environmental declaration CE1E1864 <sup>2)</sup> contains data on environmentally compatible product design and assessments (RoHS compliance, materials composition, packaging, environmental benefit, disposal).	
Weight	Incl. packaging	
	QFM21..	Approx. 0.18 kg

1) Does not apply to the **QFM2160** duct sensor!

2) The documents can be downloaded from <http://siemens.com/bt/download>.

**QFM2160**

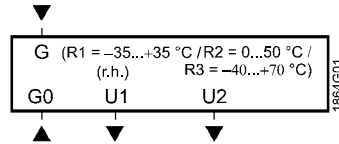

**QFM2120**

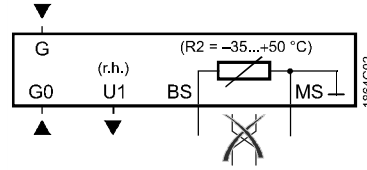

**QFM2100**

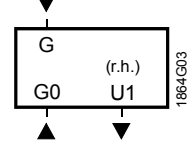

**QFM2101**

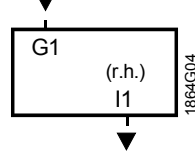

**QFM2171**

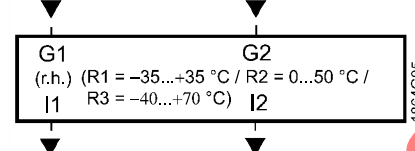

- G, G0     Operating voltage AC 24 V (SELV) or DC 13.5...35 V
- G1, G2    Operating voltage DC 13.5...35 V
- U1        Signal output DC 0...10 V for 0...100 % r. h.
- U2        Signal output DC 0...10 V for temperature range 0...50 °C (R2 = factory setting),  
-35...+35 °C (R1) or -40...+70 °C (R3)
- I1        Signal output 4...20 mA for 0...100 % r. h.
- I2        Signal output 4...20 mA for temperature range 0...50 °C (R2 = factory setting),  
-35...+35 °C (R1) or -40...+70 °C (R3)
- BS, MS    Signal output LG-Ni 1000 for temperature range -35...+50 °C (passive, simulated);  
wires must not be interchanged

*Note on connection terminals of the QFM2171:*

Terminals G1(+) and I1(-) for the humidity output must always be connected to power, even if only the temperature output G2(+) and I2(-) is used!



# Dimensions

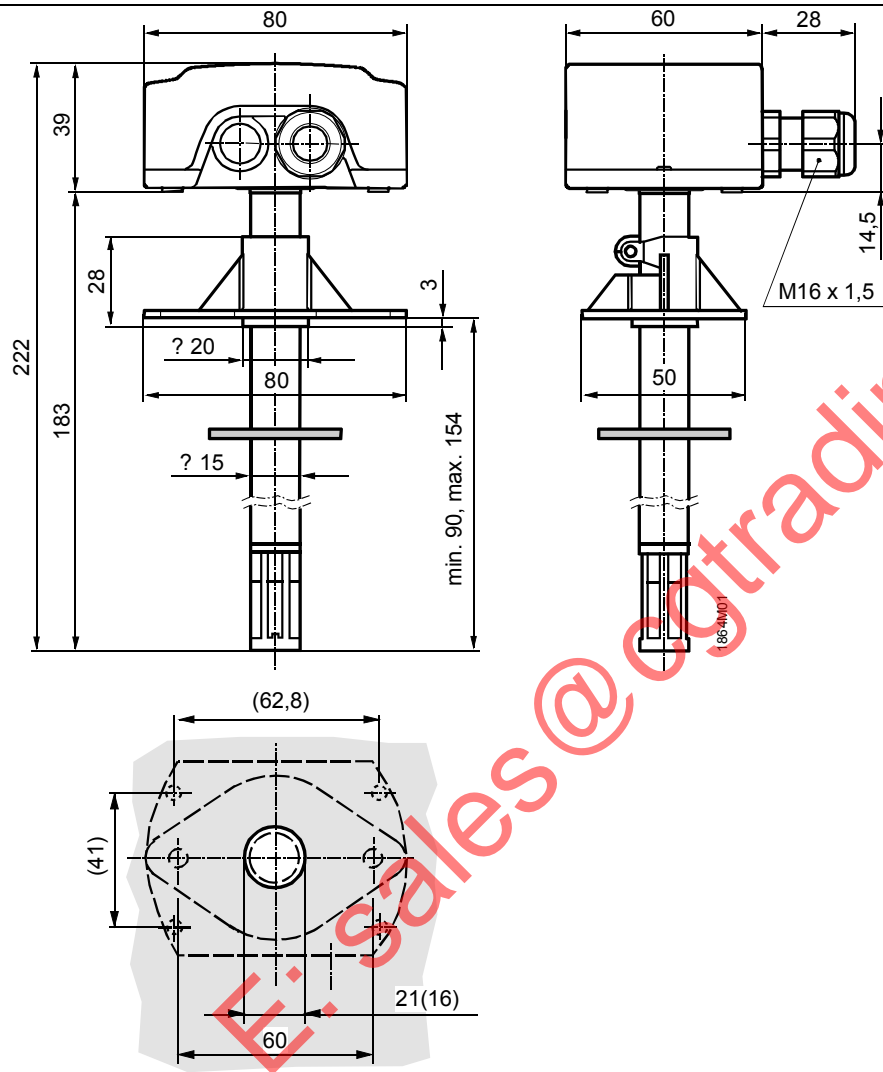

Drilling plan with (without) mounting flange

Dimensions in mm

www.cgtrading.in E: sales@cgtrading.in

www.cgtrading.in E: sales@cgtrading.in

Issued by:  
Siemens Switzerland Ltd.  
Building Technologies Division  
International Headquarters  
Theilerstrasse 1a  
CH-6300 Zug  
Tel. +41 58 724 2424  
[www.siemens.com/buildingtechnologies](http://www.siemens.com/buildingtechnologies)

© Siemens Switzerland Ltd 2006 - 2018  
Technical specifications and availability subject to change without notice.